

FIG. 1

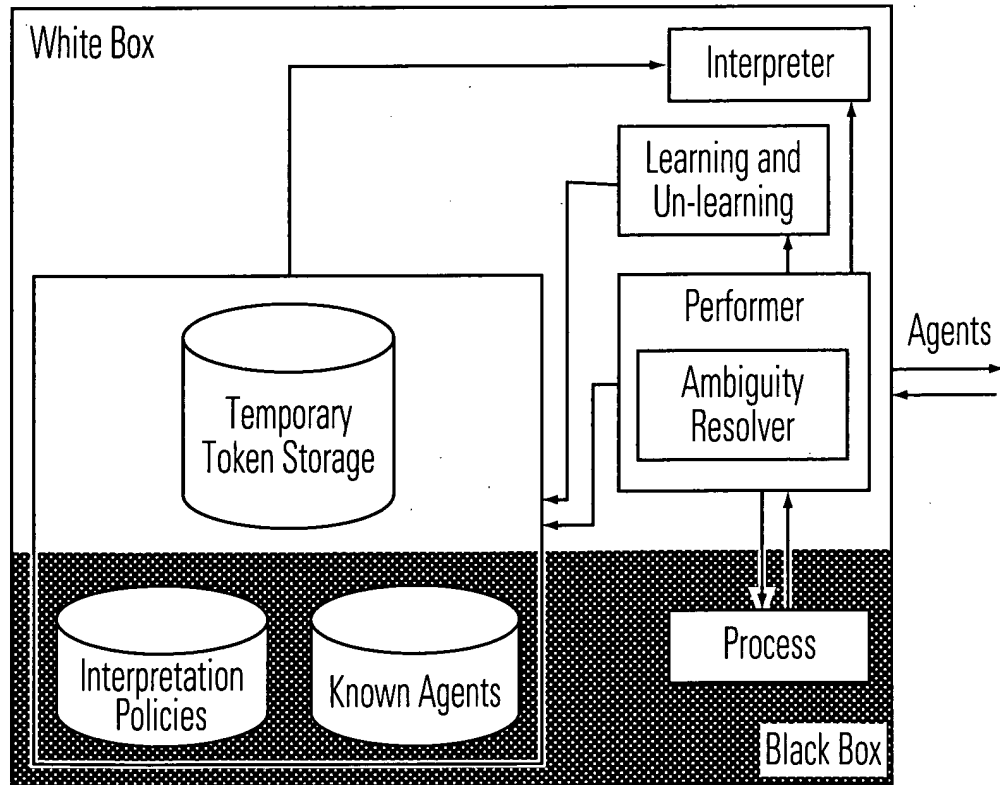
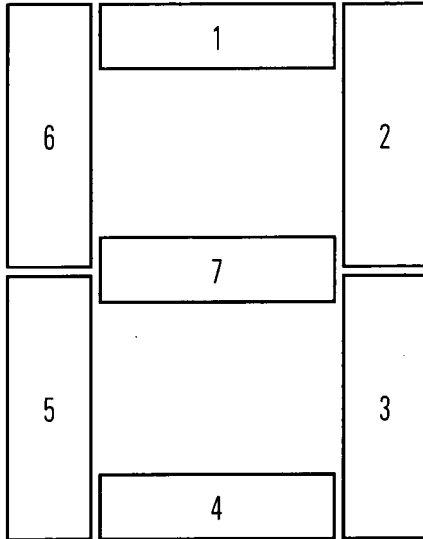
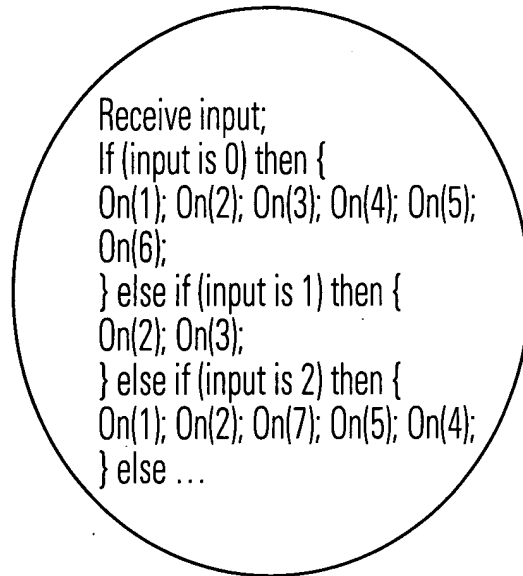

FIG. 2



A seven-segment display

FIG. 3A



The centralized approach

FIG. 3B

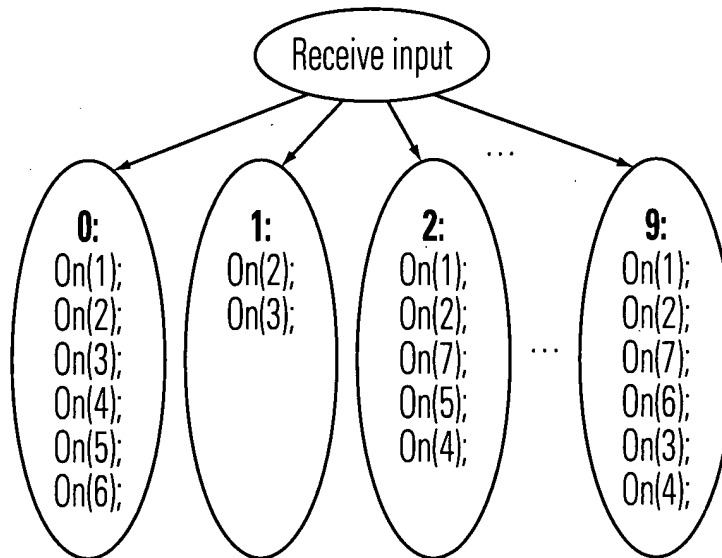

Simple AAOSA hyperstructure.
Each agent's interpretation policy is to
check input against the number it represents.

FIG. 3C

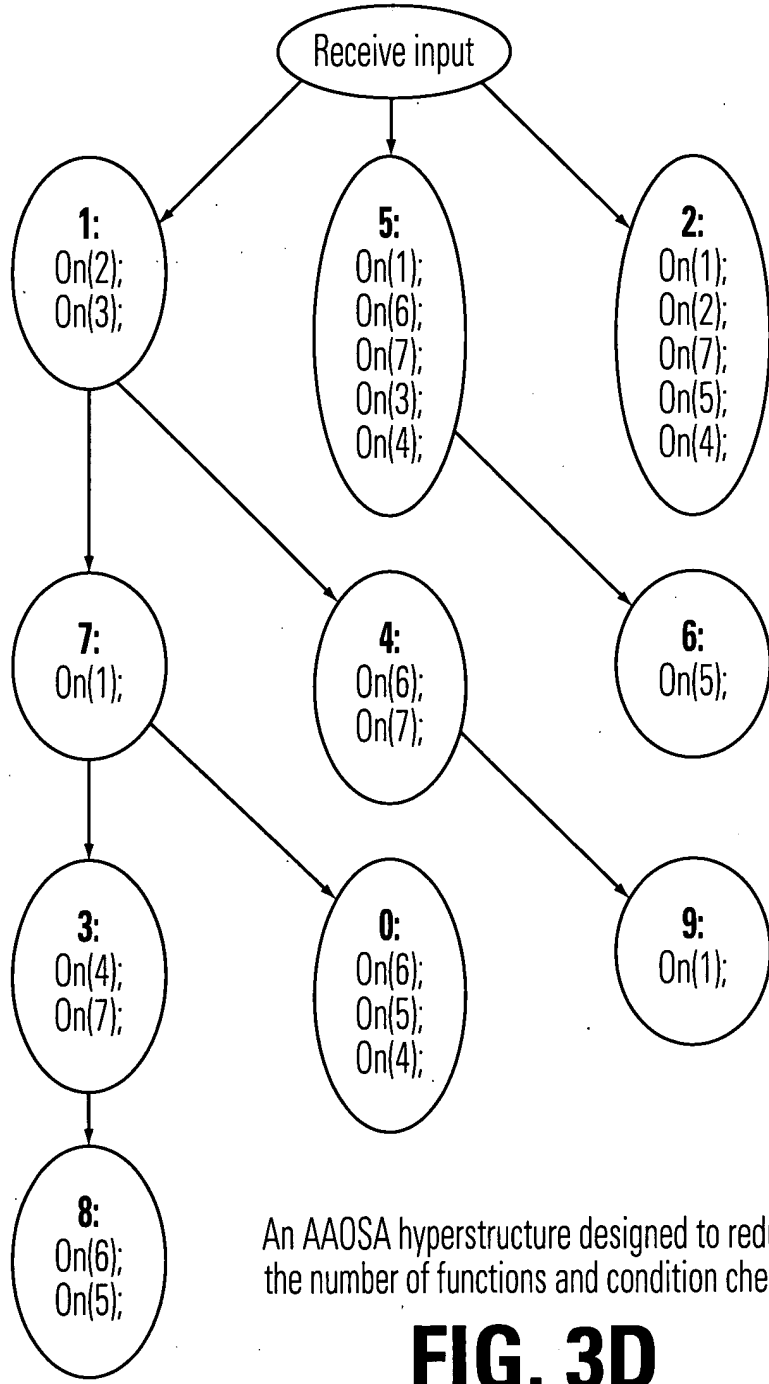

An AAOSA hyperstructure designed to reduce the number of functions and condition checks

FIG. 3D

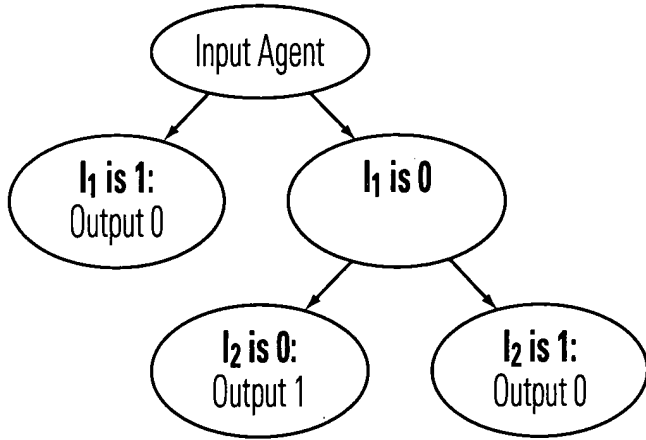

FIG. 4

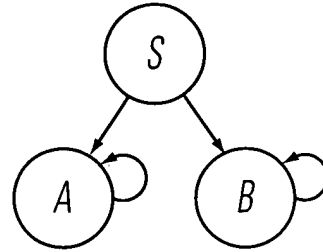

FIG. 5

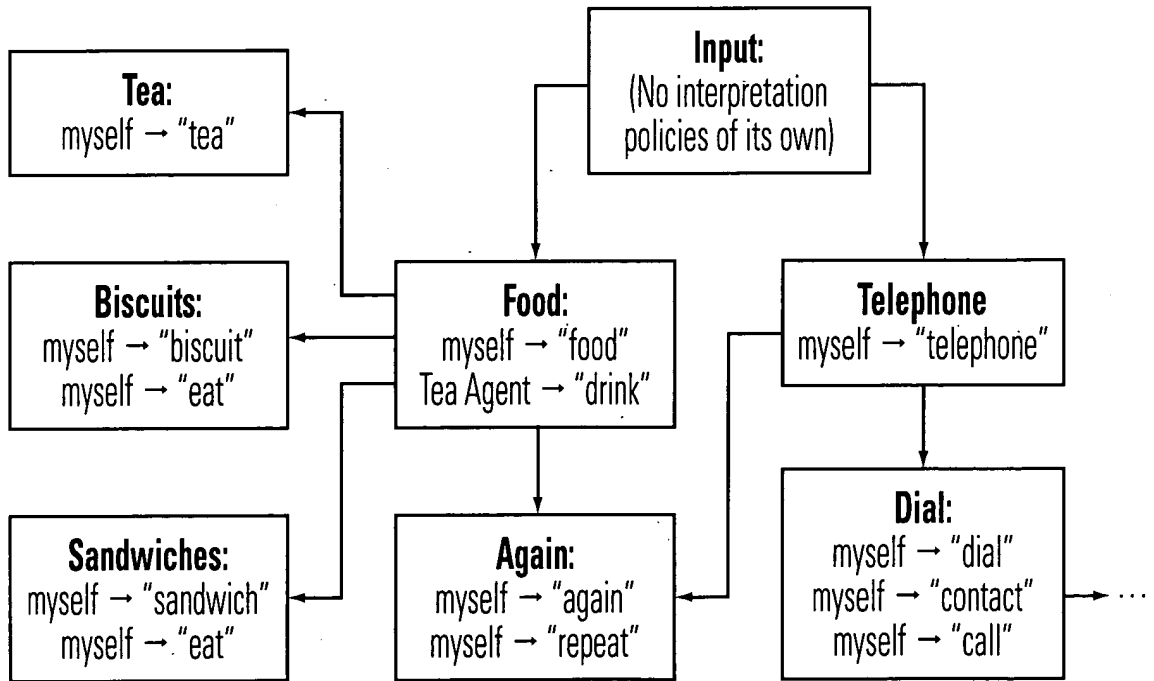

FIG. 6

5/5

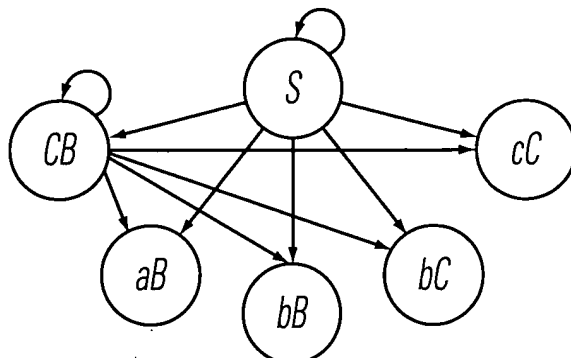

FIG. 7

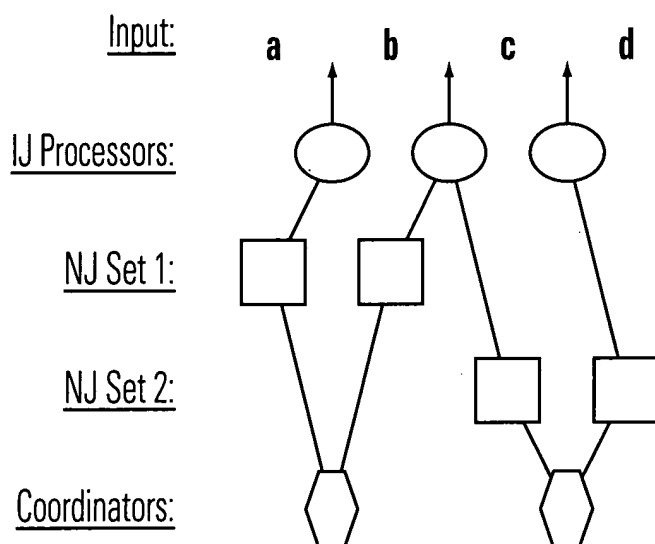

FIG. 8

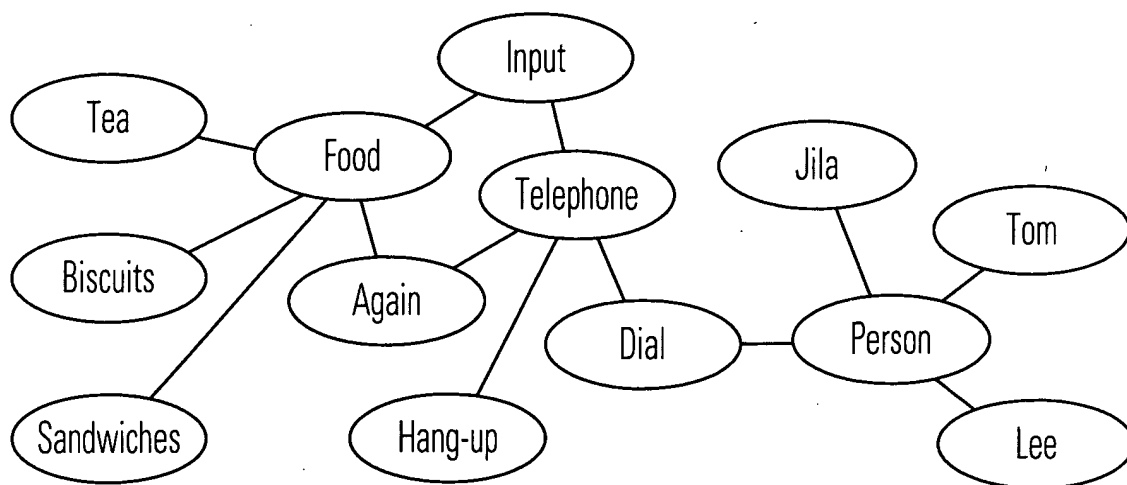

FIG. 9